

CATALOG NUMBER: E-SCA00W310 FOR ONE 310 WATT, S 67 HIGH PRESSURE SODIUM LAMP

Line Voltage	120/208/240/277 V
Regulation	
Line Volts	+/-10%
Line Watts	WHITIN TRAPEZOID
Frequency	60 Hz
Circuit Type	CWA
Power Factor (min)	90%
Insulation Class	H(180°)
Min. Ambient Starting Temp.	-40° F or -40° C

4 1/4" x 4 3/4" CORE

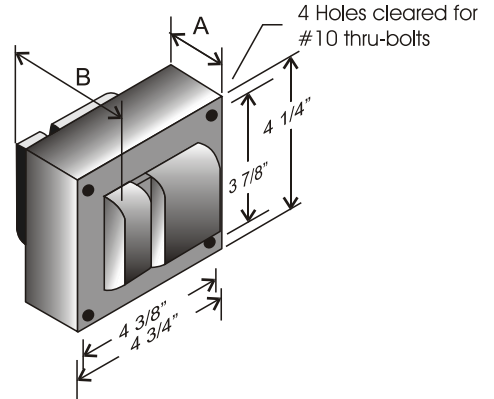

CORE AND COIL

Dimension A (inches)	2.20
Dimension B (inches)	4.0
Weight (lbs)	13.7
Lead Lengths (inches)	12

Line Voltage (Volts)	120	208	240	277
Line Current (Amps)				
Operating	3.0	1.73	1.50	1.30
Open Circuit	2.30	1.26	1.13	0.98
Starting	1.86	1.10	0.94	0.82
Input Watts (W)	355	355	355	355
Open Circuit Voltage (V)	185	185	185	185
Drop Out Voltage	90	155	180	210
UL(1029) Bench Top Rise	C	B	B	B
Recommended Fuse (Amps)	8	5	5	5

HIGH POTENTIAL TEST (VOLTS)					
1 Minute	2000				
2 Seconds	2500				
Open Circuit Voltage Test (volts)	165-205				
Short-Circuit Current Test (Amps)					
Secondary Current Input Current	4.5-5.4	1.50-1.95	0.85-1.10	0.70-1.0	0.62-0.85

BRACKET

CORE & COIL
MOUNTING BRACKET

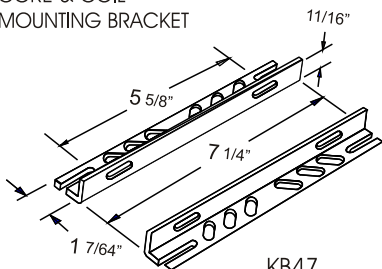

KB47
Mounting bracket for
Core & Coil Ballasts
(2 brackets with thru bolts)

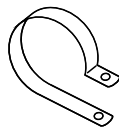

C-01
MOUNTING CLIP for round case (Furnished as standard with B suffix ballast)

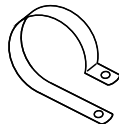

I-01
MOUNTING CLIP for oval case (Furnished as standard with B suffix ballast)

CAPACITOR

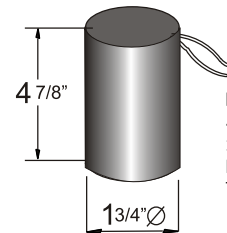

RATING
45 Mfd ± 3%
280 VAC MIN
Dry Film Capacitor
Thermal Plastic Case
Max. Case Temp 100° C

IGNITOR 37-63-AS-6.9-N6

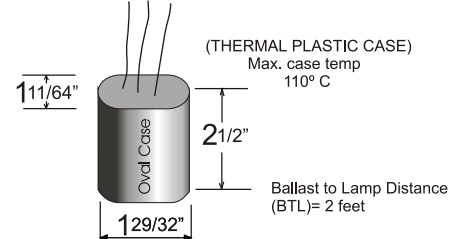

(THERMAL PLASTIC CASE)
Max. case temp 110° C

Ballast to Lamp Distance (BTL)= 2 feet

WIRING DIAGRAM

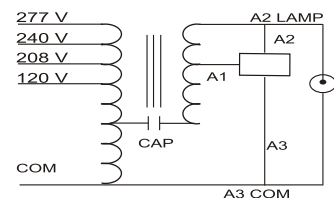

MULTI VOLTAGE
120/208/240/277 VOLT CONNECTION

ORDERING INFORMATION

*** Add proper suffix to catalog number when ordering as indicated below:
No suffix = Core and Coil Only
B = Core and Coil, and Bracket
C = Core and Coil, and Capacitor
BC = Core and Coil, Capacitor and Bracket

Data is based upon tests performed by Industrias Sola Basic in a controlled environment and representative of relative performance. Actual Performance can vary depending on operating conditions. Specifications are subject to change without notice.

Made in Mexico by Industrias Sola Basic S.A de C.V.

G01



Lighting & Power Source LP.
2707 Realty Road, Suite 110
Carrollton, TX 75006 USA
Tel: (972) 416-4500
Fax: (972) 418-5858