

CATALOG NUMBER: E-SZA0FT100F FOR ONE 100 WATT, S54 HIGH PRESSURE SODIUM LAMP

Line Voltage	120/277V
Regulation	
Line Volts	+/- 5%
Lamp Watts	WITHIN TRAPEZOID
Frequency	60 Hz
Circuit Type	HX-HPF
Power Factor (min)	90%
Insulation Class	A(105°)
Min. Ambient Starting Temp.	-40° F or -40° C

Line Voltage (Volts)	120	277
Line Current (Amps)		
Operating	1.15	0.50
Open Circuit	1.95	0.65
Starting	1.10	0.35
Input Watts (W)	125	125
Open Circuit Voltage (V)	120	120
Drop Out Voltage (V)	95	220
UL(1029) Bench Top Rise		
Recommended Fuse (Amps)	6	3
HIGH POTENTIAL TEST (VOLTS)		
1 Minute	2000	
2 Seconds	2500	
Open Circuit Voltage Test(volts)	110-130	
Short-Circuit Current Test (Amps)		
Secondary Current	2.6 - 2.9	
Input Current (Amps)	0.85 - 1.15	0.80 - 0.90

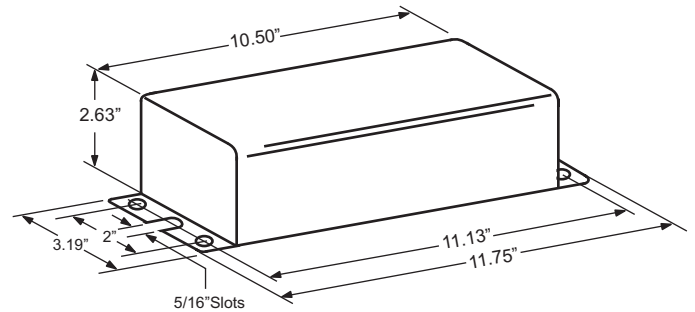

Weight (Lbs)	12.2
Lead lengths (Inches)	12.00
Sound rating	B

IGNITOR: IN CAN

The ignitor is included as part of the potted assembly. Ballast to Lamp distance (BTL)= 30 feet. Temp. Rating: 90° C

WIRING DIAGRAM

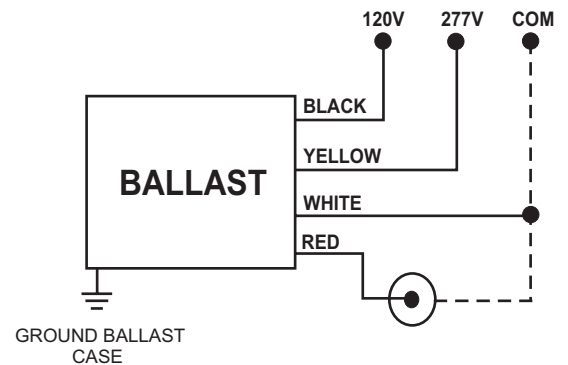

120/277 VOLT CONNECTION

Data is based upon tests performed by Industrias Sola Basic in a controlled environment and representative of relative performance. Actual Performance can vary depending on operating conditions. Specifications are subject to change without notice.

ISO 9001:2000



Made in Mexico by Industrias Sola Basic S.A de C.V.